

I iPR20W

Proyector LED extraplano de 20W

Producto



Dimensiones

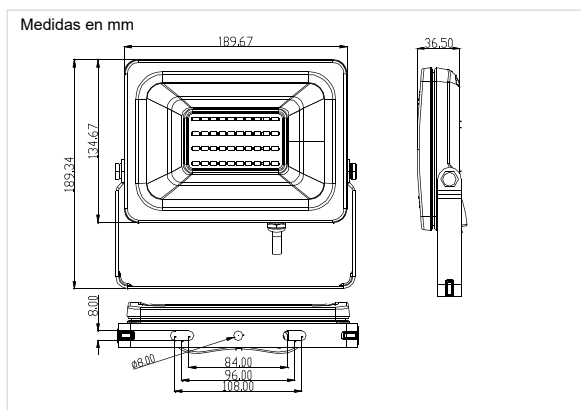

Datos Técnicos

Entrada:	110~240Vac 50/60Hz
Potencia:	20W
Nº de LEDs:	40 chips SMD 5730
Factor Potencia:	>0.90
Eficiencia Lumínica:	80 lm/w
Potencia LED:	0.50W
Flujo Lumínico:	1600 lm (BF) 1580 lm (BN) 1560 lm (BC)
Intensidad Lumínica:	750cd
Grado de IK:	08
Grado de IP:	IP65
Temp. Trabajo:	-10°C +40°C
Nº Conmutaciones:	15.000
Certificaciones:	CE, RoHS
Eficiencia Energética:	A
Vida útil:	25.000h (L70:B10)
Peso:	1060 gramos

Datos Fotométricos

Ángulo de apertura =120°
Flujo Lumínico =1600 lm
Tª de color CCT =6000K (BF)
IRC =>70

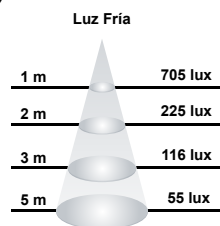
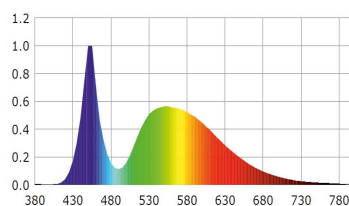

Ángulo de apertura =120°
Flujo Lumínico =1580 lm
Tª de color CCT =4000K (BN)
IRC =>70

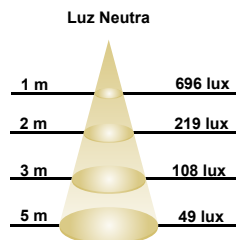
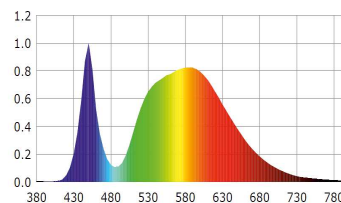

Ángulo de apertura =120°
Flujo Lumínico =1560 lm
Tª de color CCT =3000K (BC)
IRC =>70

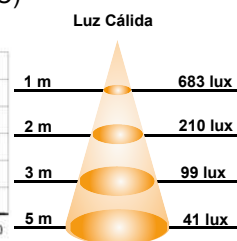
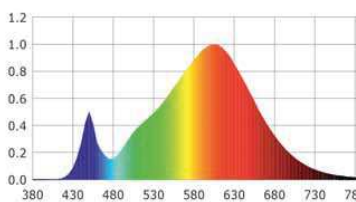

Curva de Distribución Lumínica

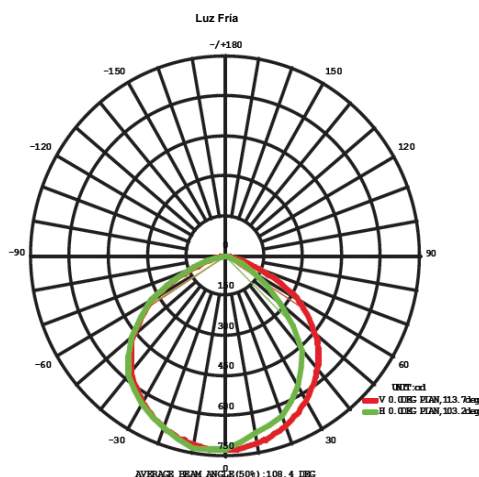

Chip utilizado

EPISTAR



ThreeLine
TECHNOLOGY